







CONTENTS

 1 • CONDITIONER DESCRIPTION	p. 2
 2 • TECHNICAL SPECIFICATIONS	p. 3
 3 • CELLAR INSULATION	p. 3
 4 • INSTALLING THE CONDITIONER	
I- General points	p. 4
II- Drilling the wall	p. 5
III- Fitting	p. 5
IV- Discharging condensate	p. 7
 5 • INSTALLING THE REMOTE CONTROL	
I- Remote control description	p. 8
II- Installing the remote control inside the cellar	p. 8
III- Installing the remote control outside the cellar	p. 9
a- Connecting the sensor to the remote control	p. 9
b- Programming the remote control	p. 10
c- Fitting	p. 10
 6 • MAINTENANCE	p. 11
 7 • OPERATING FAULTS	p. 11

I - CONDITIONER DESCRIPTION

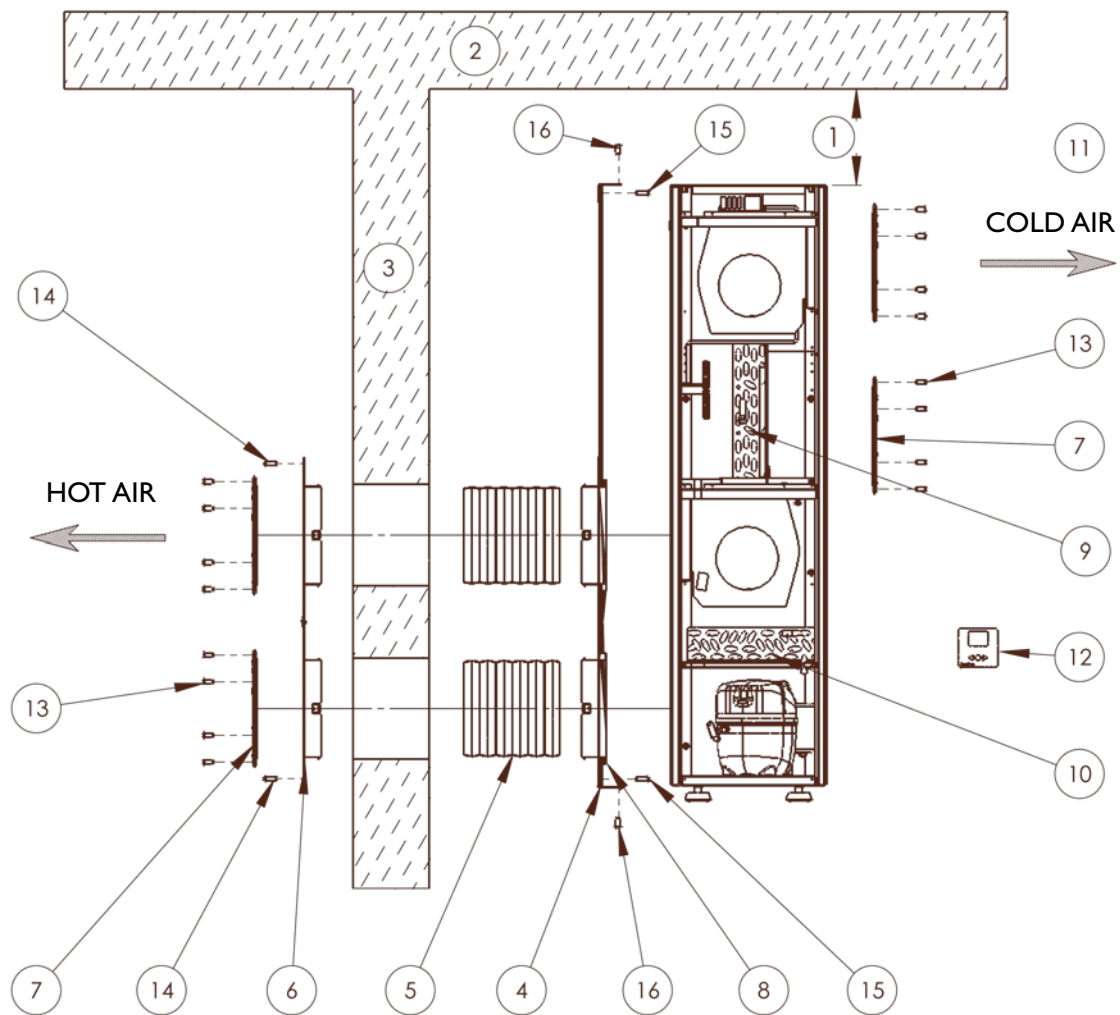

- | | | | |
|-----|---|------|--|
| 1 - | Conditioner / ceiling distance: 200 mm min. | 10 - | Condenser, to be cleaned regularly |
| 2 - | Ceiling | 11 - | Inside of cellar |
| 3 - | Cellar wall | 12 - | Remote control |
| 4 - | Metal mounting frame | 13 - | Grid securing screws (quantity: 24) |
| 5 - | Flexible ducting | 14 - | Aesthetic front panel securing screws (quantity: 4) |
| 6 - | Aesthetic front panel | 15 - | Screws to fix frame to the wall (quantity: 4) |
| 7 - | Grid, to be cleaned regularly (see p.11) | 16 - | Screws to fix conditioner to the frame (quantity: 4) |
| 8 - | Mounting frame / conditioner seal | | |
| 9 - | Evaporator, to be cleaned regularly | | |



2 - TECHNICAL SPECIFICATIONS

	Dimensions in mm	Power supply	Sample volume m ³	Cooling capacity W	Weight Kg	Electrical power W	Heating resistance W	Refrigerant	External temperatures
Inoa 25	W385 x D322 x H1250	230 V / 50 Hz	up to 25 m ³ *	600 W**	43 Kg	550 W**	650 W	R134a (without CFCs)	-5°C to 35°C
Inoa 50	W385 x D322 x H1250	230 V / 50 Hz	up to 50 m ³ *	1200 W**	46 Kg	800 W**	650 W	R134a (without CFCs)	-5°C to 35°C

* in a very well insulated room - ** for an internal temperature of 12° C and an external temperature of 32° C.
Supplied with a 3.50 m power lead without plug.



3 - CELLAR INSULATION

Traditional building materials such as stone, concrete and brick are very poor insulators and only underground sections represent any real insulation. It is therefore essential, in the majority of cases, to insulate the entire room to be conditioned.

Insulate – yes but how?

We recommend that you use extruded polystyrene, currently the most efficient product on the market. It is the least flammable and the most durable material. It also has the advantage of not being attacked by rodents. Furthermore, extruded polystyrene boards can be layered and therefore prevent thermal bridges. To increase your conditioner's lifespan and reduce electricity consumption, we recommend that you use extruded polystyrene which is at least 80 mm thick.

80 mm of extruded polystyrene provides the same amount of insulation as a 5m thick stone wall.

The insulation must be completely continuous (no gaps).

To allow air to be renewed in your cellar, it is recommended that you create an opening (of approximately 3 x 10 cm) at the top of the room and leave a 2 cm air gap under the door. As in natural cellars, this "breather effect" will ensure a constant and gradual renewal of air.

Insulation boards: different methods of fitting are possible

How can you determine whether or not a material is a good insulator? The insulation performance of a material is established by its R thermal resistance (m².°C/W). It determines the material's ability to conduct heat.

$R = e/\lambda$ - The greater the R coefficient, the better the insulation. (λ = thermal conductivity coefficient)

There are 3 types of insulation boards:

Insulator only, complex (with plaster cover) or sandwich (plaster both sides)

Depending on the type of insulator chosen, several methods of fitting are possible:

• Against the walls

- Standard extruded polystyrene board: pre-cut to the dimensions of the area to be conditioned, they are fitted using high-bond mortar. For a more acceptable finish, it is possible to fix rails onto which you screw the plaster board panels over the polystyrene.

- Sandwich or complex boards: the polystyrene is already integrated into the plaster board.

Whatever the method used, all kinds of decorative finishes are possible to obtain an attractive wall.

If you only want to condition a section of your room, install a plaster board dividing wall then insulate the side of the room to be conditioned.

N.B.: Before being insulated, walls must be clean. If they are too damp, clean them with a wire brush then clean with a high pressure water jet and paint with an emulsion paint.

• On the ceiling and door

The process for insulating the ceiling and door is identical to that of the walls. We recommend that you use extruded polystyrene.

• On the floor (insulation optional)

- Original clay floor: not insulating favours the passage of humidity, which is good for the wine.

- Concrete floor (for example): Concrete is a very poor insulator. A few centimetres of fine gravel can, in some cases, improve insulation.



It is essential that the surface material used for the floor (whether or not covering insulation) can support the weight of wine racks and has resistance to compression.

Tools required

- handsaw, tape measure, bricklayer's ruler, trestles, screwdriver or screw gun, drill, hammer, level, plumb line, wood mallet, spatula, precision knife...

4 - INSTALLING THE CONDITIONER



I - General points

- If the power lead is damaged, it must be replaced by a qualified electrician.
- Never damage the appliance's refrigerating circuit.

Your conditioner's power lead is supplied without a plug. "Fitting a power plug or connecting the conditioner to a junction box must be carried out by a qualified electrician.

In all cases, connection of your conditioner must be carried out on an earthed socket to prevent any risk of electric shock.

230V-13A* earthed power outlet with differential circuit breaker (30mA*) protected by a fuse.

*not valid for some countries

IMPORTANT : any electrical work must be carried out by a qualified electrician. Power outlet not valid for some countries.

Electric connection must be carried out by means of a device to ensure isolation from the mains system. The isolating device should open all of the contacts of all the poles ensuring complete disconnection in line with the conditions in over-voltage category III. Installation must be carried out in compliance with national installation regulations.

• Positioning your conditioner:

- The conditioner produces cold air inside the cellar and expels hot air outside (see diagram A).
- Do not install the conditioner facing the door of the room (risk of condensation on the door joints).
- Do not place the external section of the conditioner above a source of heat.
- For insulation reasons, there must be no windows or bay windows in the room to be conditioned.
- No piped hot water must pass through the room to be conditioned (e.g. under-floor heating).
- Is it not better to state that pipes with hot water must be insulated so that there is no heat loss?
- The exterior of the conditioner must not be located in an area subject to atmospheric exposure.
- No heat-producing appliance must be located in the area to be conditioned (e.g. refrigerator, radiator, boiler).
- Do not obstruct the air entry and exit points.
- Never place a container or object containing liquid on top of the conditioner.
- The room where the hot air is expelled must, ideally, be approximately twice as large as the wine cellar and well ventilated so that the hot air can be properly expelled.
- **Wait 48 h** before plugging in so that the fluids in the internal circuits can settle.
- Never connect several conditioners to a multi-socket.

• Recommendations:

- Fit your conditioner as close as possible to the ceiling in order to ensure uniform dispersal of cold air in the cellar.
 - We recommend that you leave a space of 200 mm between the ceiling and conditioner housing to make it easier to fit the appliance onto its base.
 - Air outlets (hot and cold) must not be obstructed by any obstacles (minimum distance: 1500 mm).
- Direct the cold air outlet so it is facing the bottles (see diagram D).

• Installation: (see B diagrams)

The conditioner was designed to be completely modular and adapt to any type of cellar.

You can, amongst other options, install it either outside or inside your cellar; position it close to the floor (fixed to the wall) or at a height (we recommend, however, installing it at a height for improved air convection).

Additionally, hot air can be expelled from different angles (to be specified when ordering): facing forwards, right or left.

You also have the option of expelling hot air outside the room by way of extractor piping (standard piping, 160 mm in diameter, not supplied).

Finally, you can choose to fit the conditioner onto a door.

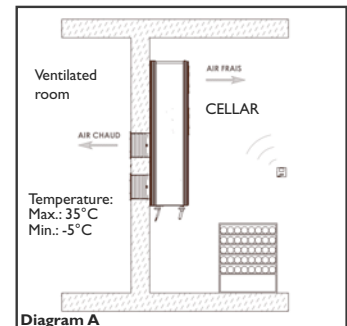

Diagram A

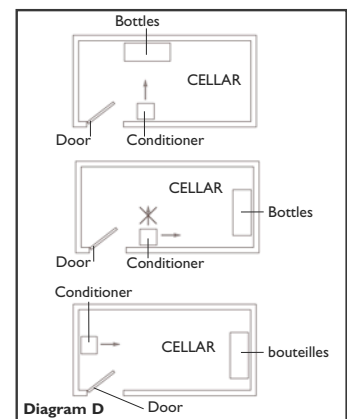

Diagram D

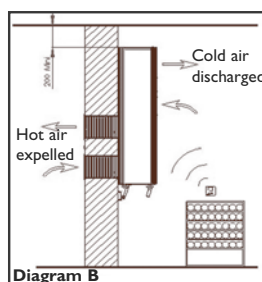

Diagram B

Conditioner housed inside the cellar with extraction facing forwards / aesthetic front panel on the outside

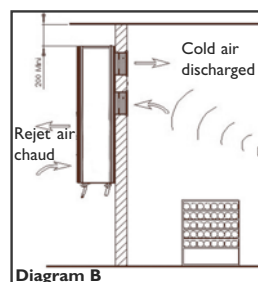

Diagram B

Conditioner housed outside the cellar with extraction facing forwards / aesthetic front panel on the inside

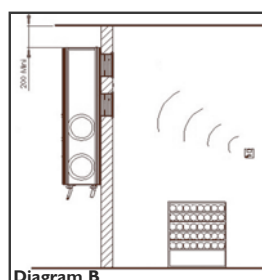

Diagram B

Conditioner housed outside the cellar with extraction on the left side / aesthetic front panel on the inside.

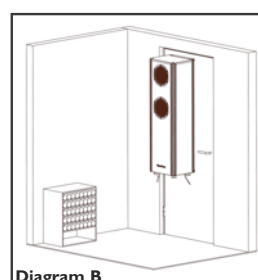

Diagram B

Conditioner housed inside the cellar, fitted onto an adapted door.



4 - INSTALLING THE CONDITIONER

• Fitting: (see C diagrams)

The conditioner comes supplied with a metallic mounting frame which simplifies the process of drilling air entry and exit holes. It also has extendable ducting to be cut to length (75 cm each) in order to install the conditioner whatever the thickness of the wall. Finally, the conditioner is supplied with an aesthetic front panel and 4 grids for an aesthetic appearance.

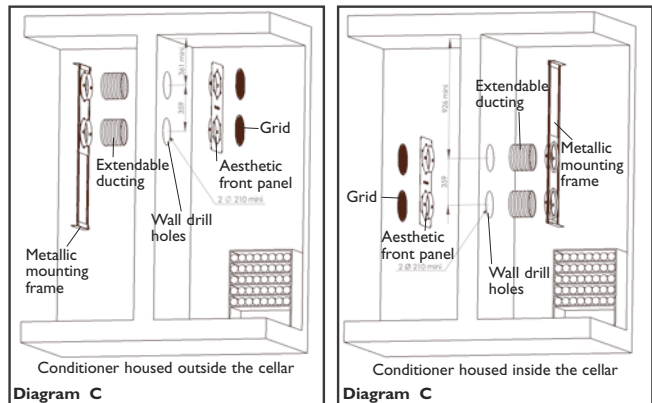

II- Drilling the wall

- Determine the location of the conditioner housing (inside or outside the cellar)
- Position the metallic mounting frame: **(1)**
 - in relation to the ceiling if fitting the conditioner at a height (maintain a distance of 200 mm between the top of the frame and the ceiling),
 - in relation to the floor for a low fitting (maintain a distance of 80 mm between the bottom of the frame and the floor).
- Use the metallic frame to outline the position of the 2 drill holes **(2)**.
- Drill the wall. The holes must be larger than the outline drawn – between 210 mm min. and 280 mm max.

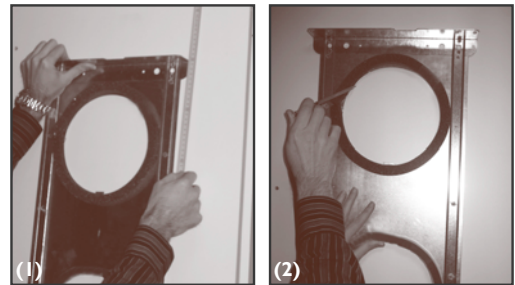

III- Fitting

- Fold the ring's 4 supports inwards **(1)**.
- Fit the 2 extendable ducts onto the rings of the metallic frame **(2)**.
- Screw the securing rings onto the ducts **(3)**.
- Position the metallic frame while passing the flexible ducts through the 2 holes drilled into the wall **(4)**.
- Push back the 4 supports towards the outside of the ring **(5)**.

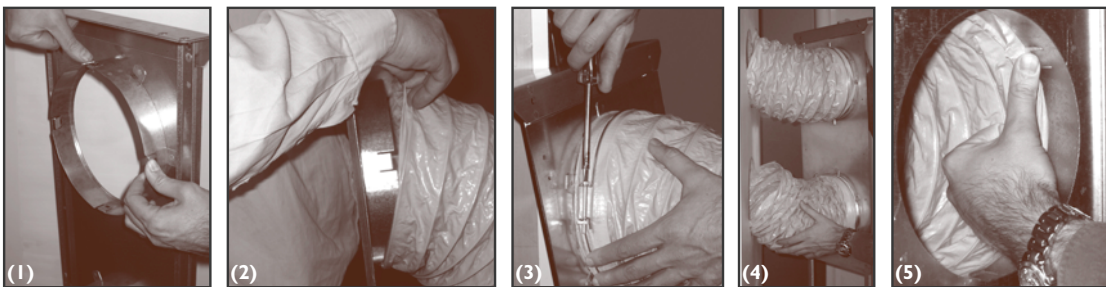

- Screw the metallic frame onto the wall with 2 high screws and two low screws (not supplied). Use screws suitable for the wall material **(6)**.
- We recommend that you put a bead of silicone between the plate and the wall to ensure effective sealing.
- Pull the 2 ducts (fixed to the metallic frame) through the other side of the wall **(7)**.
- Stretch the ducts to the maximum in order to make them as smooth as possible **(8)**.
- Cut the ducts flush with the wall using a Stanley knife for the material **(9)** and pliers for the metallic wiring **(10)**.

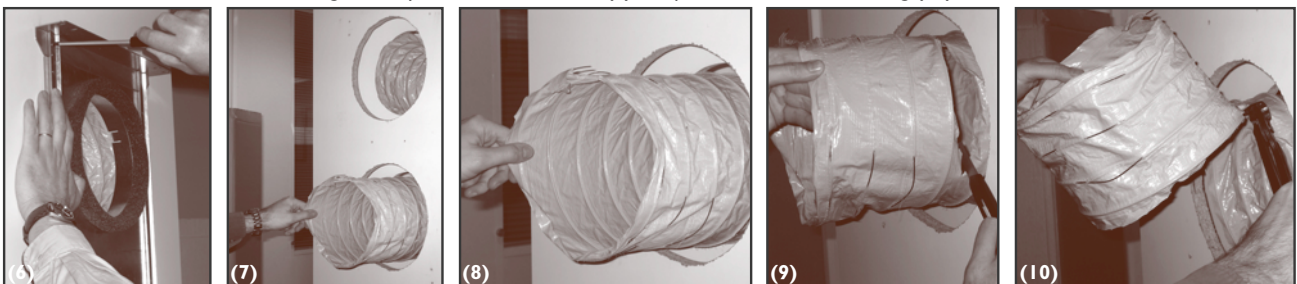

4 - INSTALLING THE CONDITIONER



- Position and fit the aesthetic front panel to the wall (screws not supplied). Use screws suitable for the wall material (11).
- We recommend that you put a bead of silicone between the panel and the wall to ensure effective sealing.
- Fold the flange's 4 supports inwards (12).
- Place the ducts onto the flanges ensuring that they are well secured on the supports (13).
- Push the 4 supports towards the outside of the flange (14).
- On the side of the conditioner to be placed against the wall unscrew the 2 grids from the housing using the supplied Hex wrench and retain the screws.) (15).

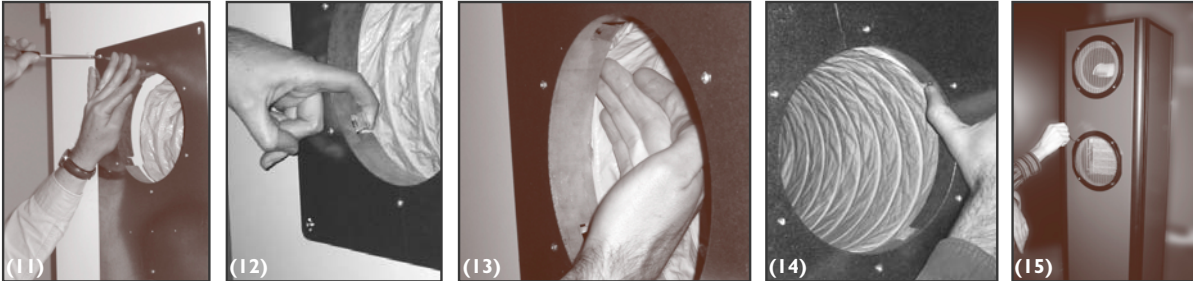

- Using the screws retained in the last instruction, screw the 2 grids onto the aesthetic front panel (16).
- Unscrew the 2 screws on the top of the conditioner using a Hex wrench (supplied), on the side to be placed against the wall. Retain the two screws (17).
- Fix the conditioner housing to the metallic frame, taking care to press firmly onto the foam (18).
- Screw down the conditioner housing using 2 screws at the top (those retained earlier) and 2 screws at the bottom (supplied in the accessories packet) (19).

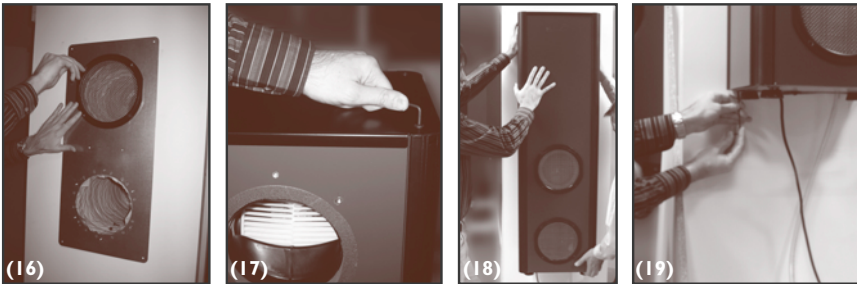

• Fitting onto a door:

You can fit the conditioner onto a door.

In this case, it is ESSENTIAL to check that the door is capable of supporting a weight of 46 kg and that it does not produce vibration. The procedure for fitting is the same as for the wall.

• Fitting close to the floor:



When the conditioner is fitted close to the floor it is ESSENTIAL that it is fixed to the wall.

• Conditioner with air extraction via piping:

Repeat the steps described at the beginning of paragraph III.

Conditioner housed outside the cellar:

- On the conditioner housing, unscrew the 2 grids (openings that will not be placed against the wall) using a Hex wrench (supplied).
- Where the grids were located, position and screw, using a Hex wrench (supplied) the 2 flanges* onto the housing (1) and (2).
- Fit together the reducer* (3).
- Position the air extraction piping (standard piping, 160 mm in diameter; not supplied).



*Supplied with the extraction kit option - see your EuroCave distributor



4 - INSTALLING THE CONDITIONER

Conditioner housed inside the cellar:

There are 2 methods for attaching the hot air extraction piping:

- Attaching the piping directly to the aesthetic front panel:

- Position and screw, using a Hex wrench (supplied), the two supplied flanges* onto the aesthetic front panel (1).
- Fit together the reducer (2).
- Position the air extraction piping (standard piping, 160 mm in diameter, not supplied) (3).

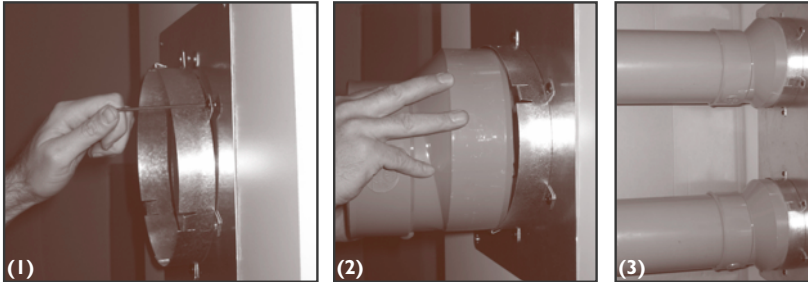

- Attaching the piping directly to the conditioner housing (the extraction piping passes through the wall):

 If using this method, you must not use the flexible ducting supplied with the conditioner.

- Fit the reducer* directly onto the mounting frame through the wall (1).
- Position the air extraction piping (standard piping, 160 mm in diameter, not supplied) (2) (3).

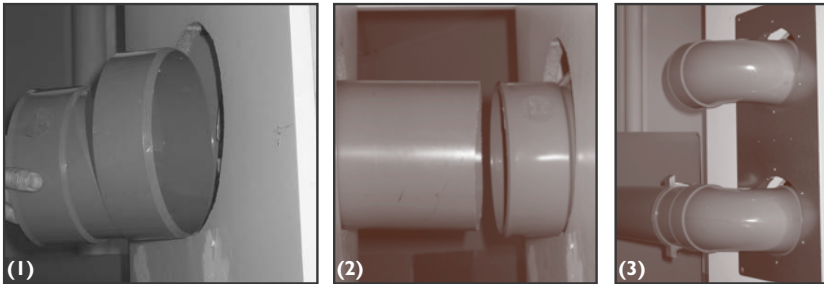

For this type of fitting, it is necessary to ensure sealing around the piping.

*Supplied with the extraction kit option - see your EuroCave distributor

IV- Discharging condensate

The conditioner was designed to allow condensate to be discharged (discharge pipe located under the conditioner's housing) either inside the cellar, if the humidity level is too low, or outside the cellar. Simply pass the pipes through the wall to discharge the condensate into the room next to the conditioner housing.

 Ensure that the piping is not cramped.

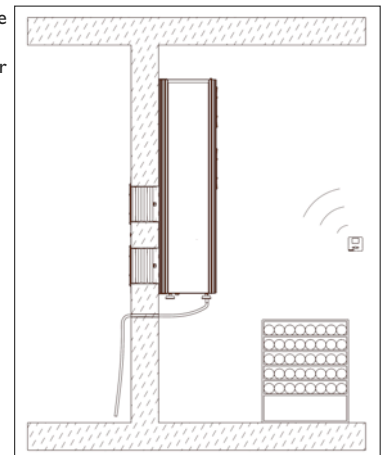

5 - INSTALLING THE REMOTE CONTROL



I- Remote control description

Radio frequency remote control (433.92 Mhz)
Each remote control has a personalised code matched to the conditioner.
Power supply: 2 x 3V (CR 2430 battery, supplied)

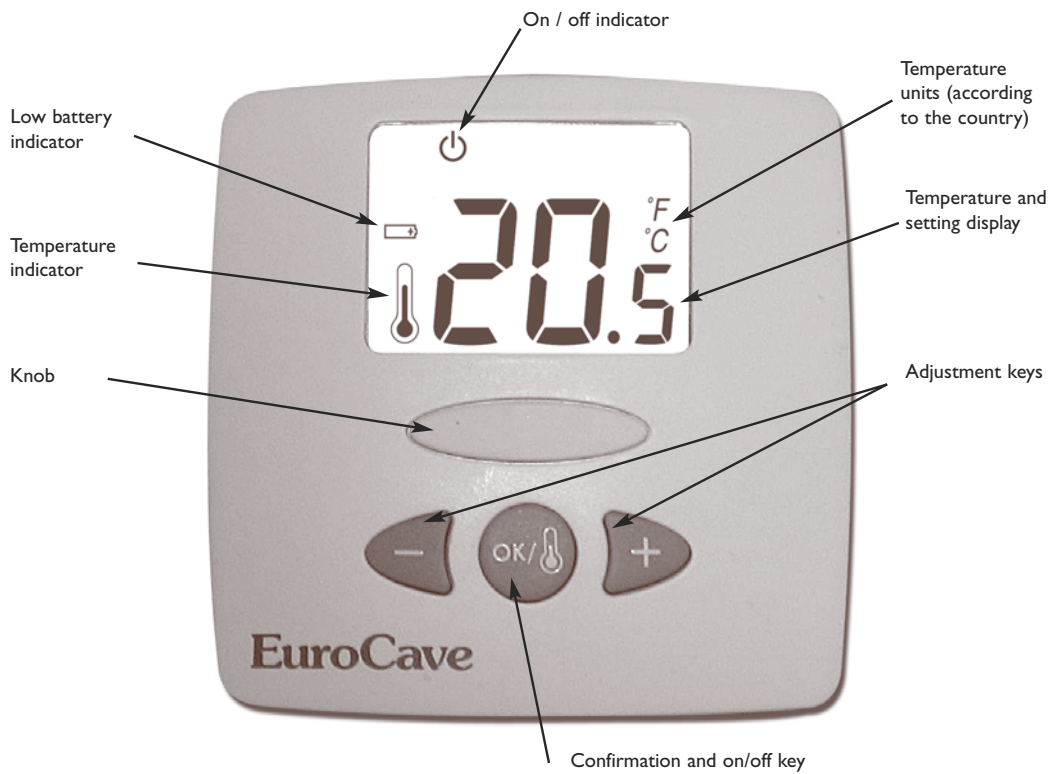

II- Installing the remote control inside the cellar

We recommend that you place the remote control as close as possible to the bottles.

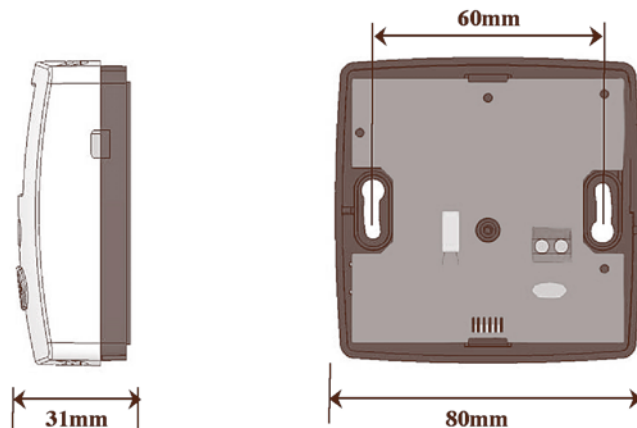

Fit the unit close to your bottles using the supplied pegs and screws (see diagram below)

NB: Do not place the remote control in the path of the conditioner's cold air flow.



5 - INSTALLING THE REMOTE CONTROL

III- Installing the remote control outside the cellar

The remote control can also be placed outside the cellar.

In this case, it is essential to connect a sensor (supplied with the appliance) to the remote control before installing it.

a- Connecting the sensor to the remote control

- On the back of the remote control, push the 2 batteries downwards using a screwdriver (see diagram below).

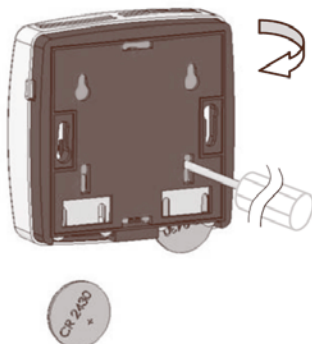

- Remove the central knob, unscrew the screw with a small screwdriver and open the unit (see diagram below)

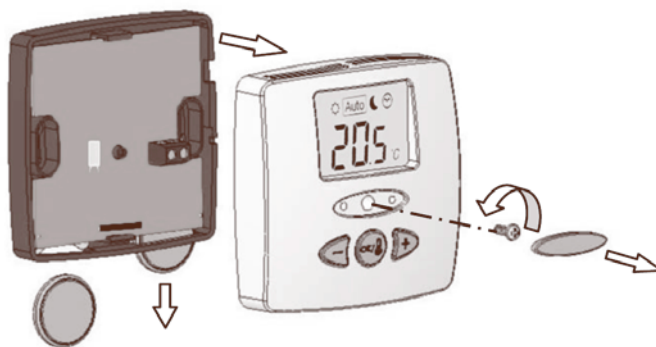

On the back, connect the sensor's 2 wires (blue and red) to the circuit connector using a small flat screwdriver (see diagram below).

You can connect either the blue wire or the red wire to the circuit connector.

Pass the wires through the recess on the top of the unit.

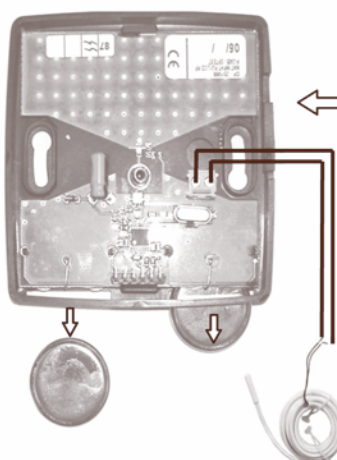

- Close the unit, ensuring that the wires pass through the recess and are not jammed





- Rescrew and replace the central knob



5 - INSTALLING THE REMOTE CONTROL





- Programming the remote control



When placing the remote control outside the cellar, having connected the external sensor, it is essential to reprogramme the unit



- To turn on the remote control, press and hold down the  key for about 8 seconds until the  indicator goes off.
- First press and continuously hold down the  key, at the same time press and continuously hold down the  key for several seconds until three

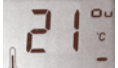

lines  appear. The model number is then displayed and flashes. .



- Press .

- The  screen appears indicating IN (IN= internal installation). Press the  key to change to OUT external mode.

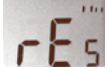

- The  display appears indicating OUT (OUT= external installation). Press  to confirm.



- The  pictogram appears. Press .

- The  screen appears. Press .

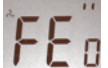
- The  pictogram appears. Press .

-  appears. Press .

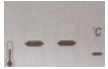
- The  pictogram appears. Press .

- The  screen appears, then .

If you wish to reprogramme the remote control for an internal sensor, disconnect the wired sensor and reprogramme the remote control in internal mode (IN) by repeating the first two steps described in the paragraph above (see 5-III-b p.11):

The 2nd screen displays  indicating OUT (OUT= external installation). Press the  key to change to IN internal mode. Press  to confirm.

Then repeat the same steps, as indicated in the above paragraph (see 5-III-b).

c- Fitting

- Fit the remote control and sensor using the screws and pegs supplied (see diagram on page 9, chapter II).
 - Place the sensor inside the cellar.
 - Place the sensor as close as possible to the bottles
- N.B.: the sensor has a range of 3 metres.



6 - MAINTENANCE



It is necessary to thoroughly clean the conditioner's internal elements every 2 years.

- Unplug the appliance.
- Place the appliance on the ground to disassemble it (4 screws).
- Vacuum the 4 air entry and exit grids.
- Remove the upper cover (2 screws) (1).
- Snap off from the top the 2 columns in order to access the 8 screws of the 2 front sections (2).
- Disassemble the front sections by removing the screws (square end pieces, not supplied).
- Thoroughly clean the ribs of the 2 exchangers with a vacuum cleaner (3).
- Repeat these instructions in the opposite order to reassemble the appliance.

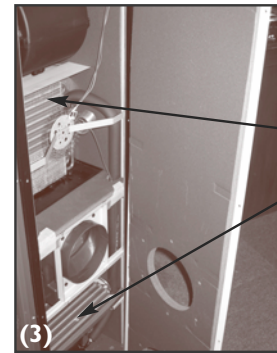
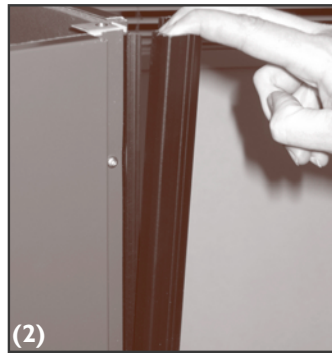
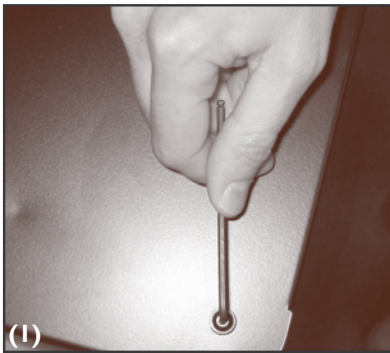

Ribs of the 2 exchangers



7 - OPERATING FAULTS

If the conditioner is not working, there may be loss of synchronism between the appliance and the remote control.

Synchronising procedure:

- Remove the conditioner housing upper cover (4 screws) (1).

- To turn on the remote control, press and hold down the  key for about 8 seconds, until the  indicator goes off.

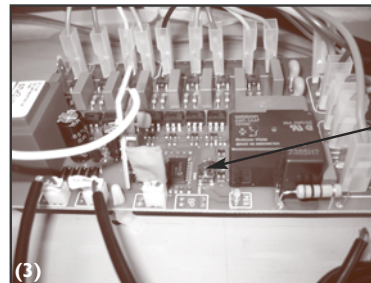
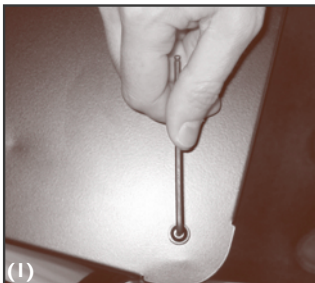

- Place the switch, located under the conditioner, in position I. The green LED on the board comes on (2).

- Press and hold down the On/Off button (brown button) on the board for more than 6 seconds, then release (3). The green LED will then start to flash (synchronising mode).



On/ off button

Green LED

- Simultaneously press the  and  keys on the remote control until ! is displayed .

- As soon as the green LED on the board stops flashing (end of synchronising mode), the conditioner and remote control are then synchronised.

11

- Exit "RF" mode by pressing the  key on the remote control.

WARNING

The information in this document is subject to modification without prior notice.

EuroCave offers no guarantee on this equipment item if it is used for any specific purpose other than that for which it was designed. EuroCave cannot be held responsible for any errors in this manual, nor for any damage linked to or following the provision, performance or use of the equipment item.

All photocopying, reproduction, translation, wether partial or total, are strictly prohibited, without prior written consent from EuroCave.